

TOY FAIR NEWS 2023



NZG Nürnberger Zinkdruckguss-Modelle GmbH



Die hier von uns aufgeführten Modelle der Firma NZG finden Sie NICHT in unserem Onlineshop. Sie können sie jedoch per E-Mail, Telefon oder Fax bestellen.

SPIELWARENMESSE
NÜRNBERG

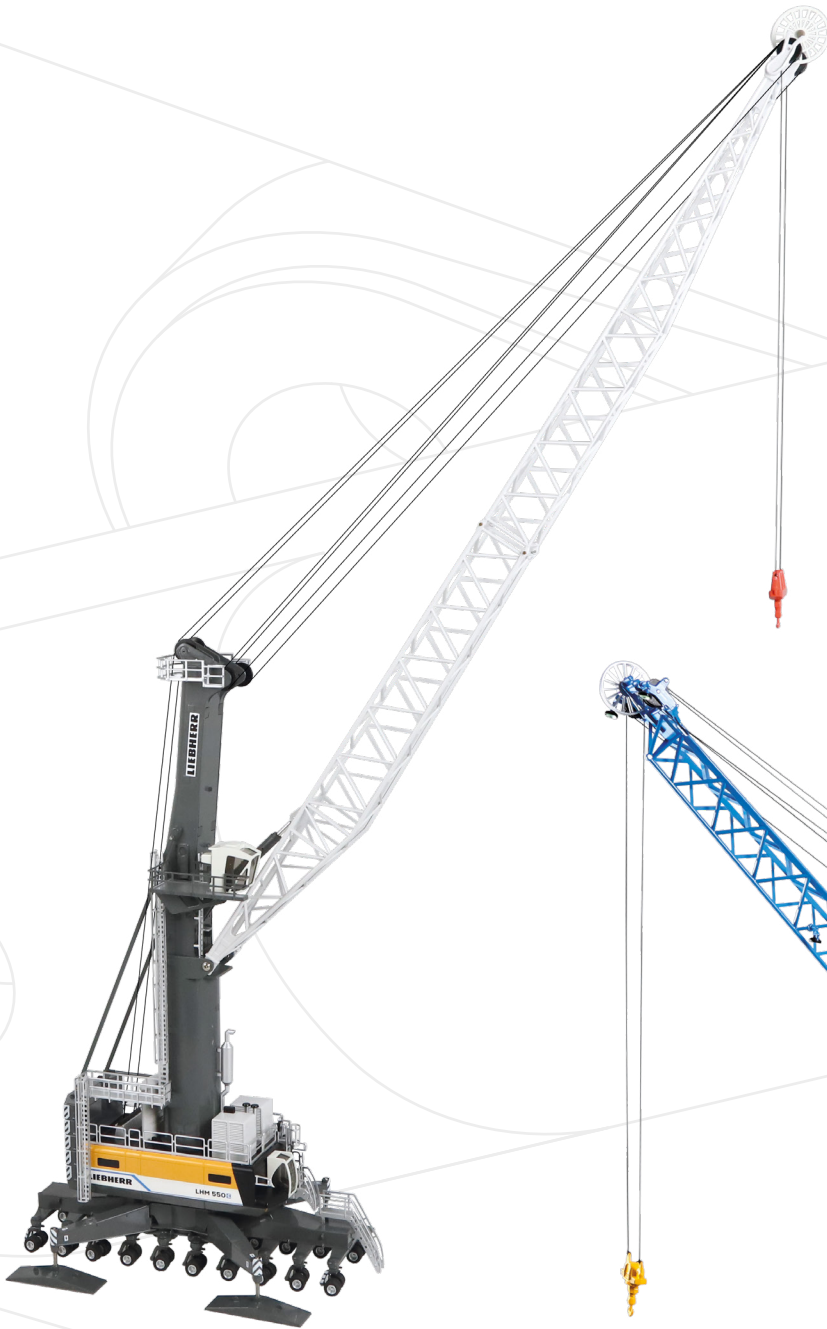

Liebherr LHM 550
Mobiler Hafenkran / Mobile harbour crane

Maßstab / Scale : 1:87
Länge / Length : 650 mm

Art.-No. 8951

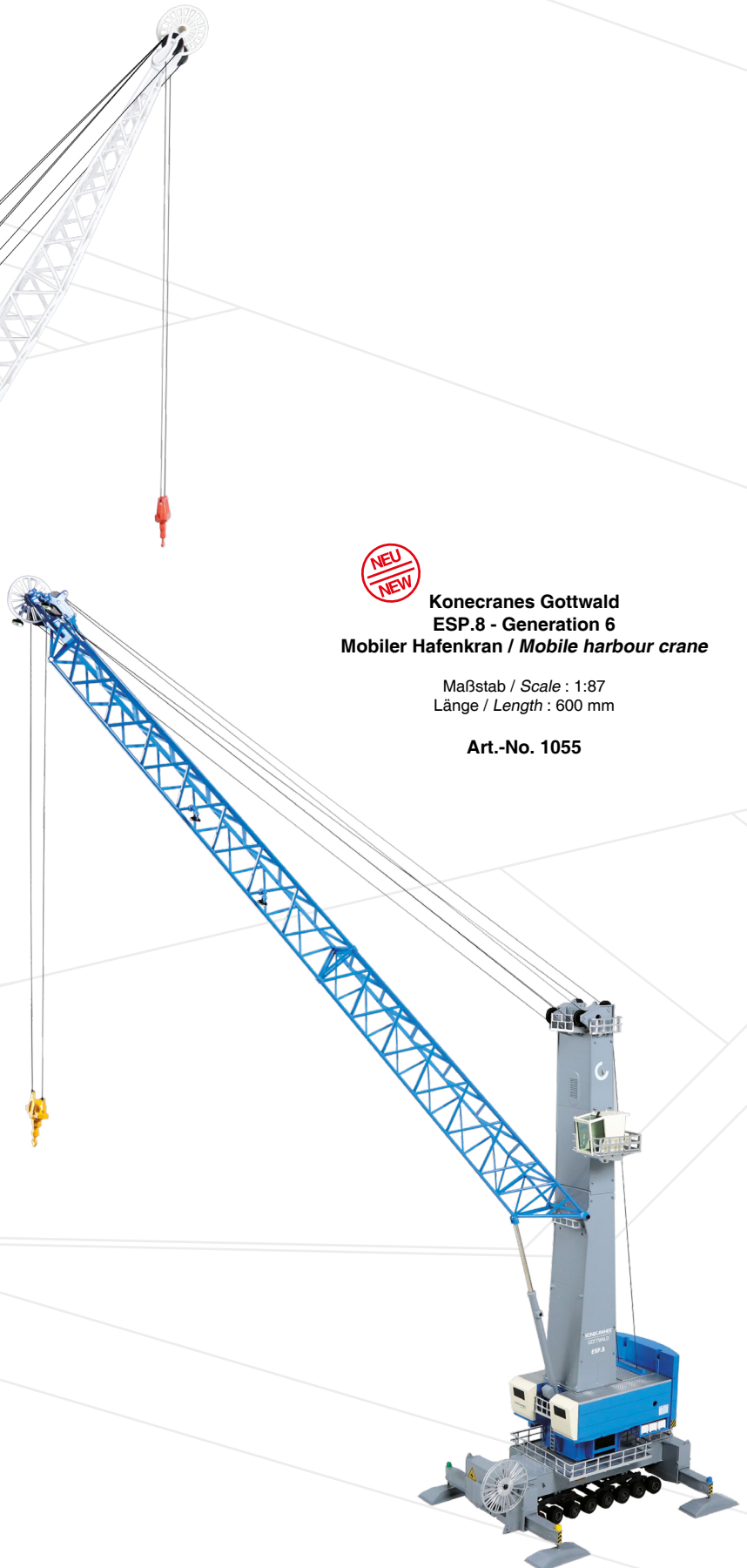

Konecranes Gottwald
ESP.8 - Generation 6
Mobiler Hafenkran / Mobile harbour crane

Maßstab / Scale : 1:87
Länge / Length : 600 mm

Art.-No. 1055

1:87



**Liebherr LTM 1250-5.1
Mobilkran / Mobile Crane
„van den Brink“**



(Newsletter 07/2022)

Maßstab / Scale : 1:50
Länge / Length : 325 mm

max. Höhe / max. height
Ausleger / Boom: 1235 mm
mit Gitterspitze / with lattice jib: 1650 mm

Art.-No. 959/21



**Baljer & Zembrod
Sortier- & Umschlagwagen /
Sorting and transferring carriage**

(Newsletter 15/2022)

Maßstab / Scale : 1:50
Länge / Length : 355 mm

Art.-No. 1045



Holzgreifer inklusive /
log grab included



**Liebherr L 504 Compact
Radlader / Wheel loader**

(Newsletter 14/2022)

Maßstab / Scale : 1:50
Länge / Length : 120 mm

Art.-No. 1035



**Liebherr L 586
Radlader / Wheel loader**

Maßstab / Scale : 1:50
Länge / Length : 200 mm

Art.-No. 10061



neues Design /
new design

**Liebherr R 9600
Tieflöffel Minenbagger /
Backhoe mining excavator**

(Newsletter 18/2022)

Maßstab / Scale : 1:50
Länge / Length : 470 mm

Art.-No. 1050





Liebherr A 918 Compact Litronic
Hydraulikbagger / Hydraulic excavator

Maßstab / Scale : 1:50
 Länge / Length : 145 mm

Art.-No. 9432



neues Design /
 new design



neues Design /
 new design



Liebherr LH 22 M Litronic
Materialumschlagmaschine /
Material handler

Maßstab / Scale : 1:50
 Länge / Length : 190 mm

Art.-No. 10012



Liebherr PR 736 G8
Planierdraupe / Crawler tractor

Maßstab / Scale : 1:50
 Länge / Length : 150 mm

Art.-No. 10101



neues Design /
 new design

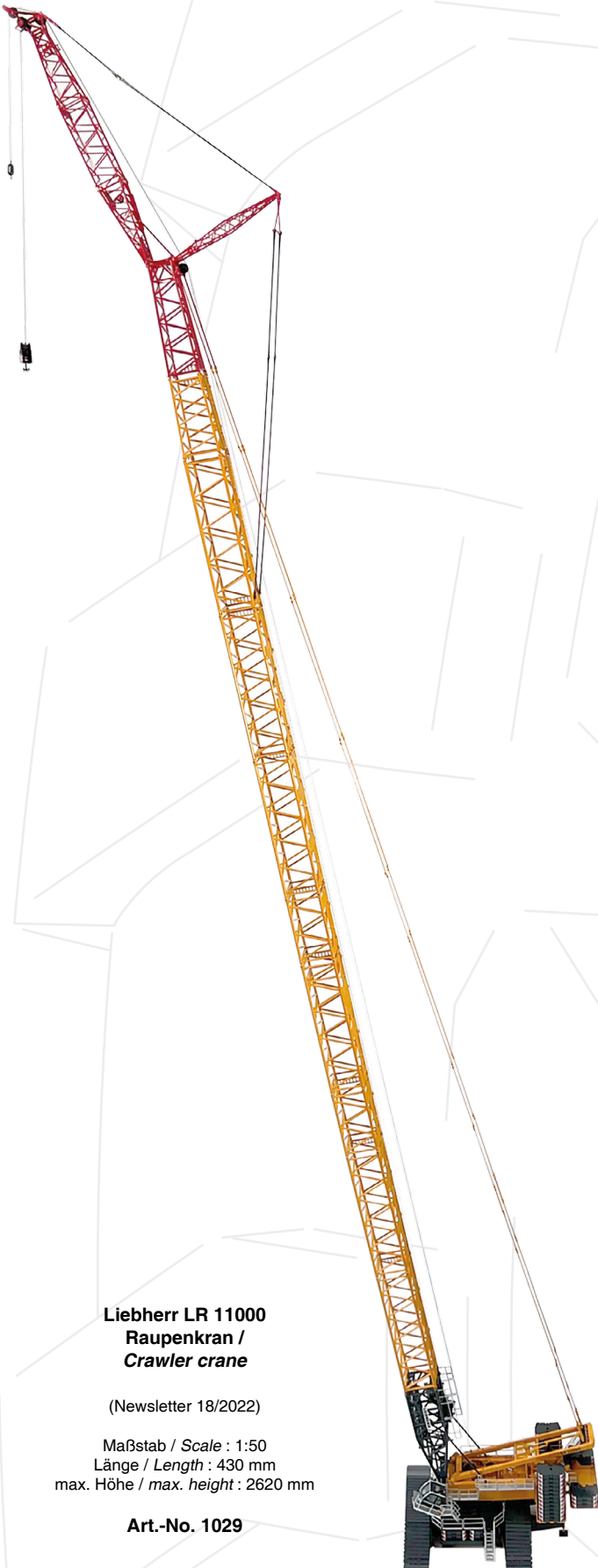

Liebherr LR 11000
Raupenkran /
Crawler crane

(Newsletter 18/2022)

Maßstab / Scale : 1:50
 Länge / Length : 430 mm
 max. Höhe / max. height : 2620 mm

Art.-No. 1029



inklusive Fallgewicht /
 including falling weight

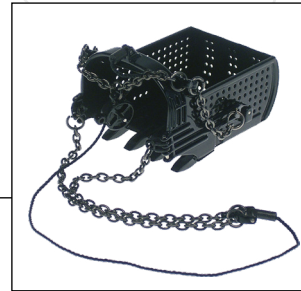

inklusive Schleppschaufel /
 including tugshovel



Liebherr HS 8130.1 HD
Seilbagger /
Duty cycle crawler crane

(Newsletter 18/2022)

Maßstab / Scale : 1:50
 Länge / Length : 400 mm
 max. Höhe / max. Height : 670 mm

Art.-No. 1046



Vögele Super 1900-5i
Straßendeckenfertiger /
Tracked paver

(Newsletter 18/2022)

Maßstab / Scale : 1:50
Länge / Length : 145 mm

Art.-No. 1039



Vögele Super 2100-5i
Straßendeckenfertiger /
Tracked paver

(Newsletter 18/2022)

Maßstab / Scale : 1:50
Länge / Length : 150 mm

Art.-No. 1040



Kleemann MSS 802i EVO
Mobile Siebanlage /
Mobile screening plant

(Newsletter 18/2022)

Maßstab / Scale : 1:50
Länge / Length : 370 mm

Art.-No. 1044

Kleemann MC 110 EVO2
Mobiler Backenbrecher /
Mobile jaw crusher

Maßstab / Scale : 1:50
Länge / Length : 330 mm

Art.-No. 1043



Hamm HC 119
Walzenzug mit Glattbandage & Schutzdach /
Compactor with smooth roller drum & roof

(Newsletter 18/2022)

Maßstab / Scale : 1:50
 Länge / Length : 120 mm

Art.-No. 1042



Hamm HC 119i
Walzenzug mit Glattbandage & Schutzdach /
Compactor with smooth roller drum & roof

(Newsletter 18/2022)

Maßstab / Scale : 1:50
 Länge / Length : 120 mm

Art.-No. 10421

Hamm HC 200
Walzenzug mit Glattbandage /
Compactor with smooth roller drum

(Newsletter 18/2022)

Maßstab / Scale : 1:50
 Länge / Length : 135 mm

Art.-No. 1041



Hamm HC 200i C
Walzenzug mit Glattbandage /
Compactor with smooth roller drum

(Newsletter 18/2022)

Maßstab / Scale : 1:50
 Länge / Length : 135 mm

Art.-No. 10411

Wirtgen 220 SM 3.8
Surface Miner

(Newsletter 11/2022)

Maßstab / Scale : 1:50
 Länge / Length : 210 mm

Art.-No. 1036



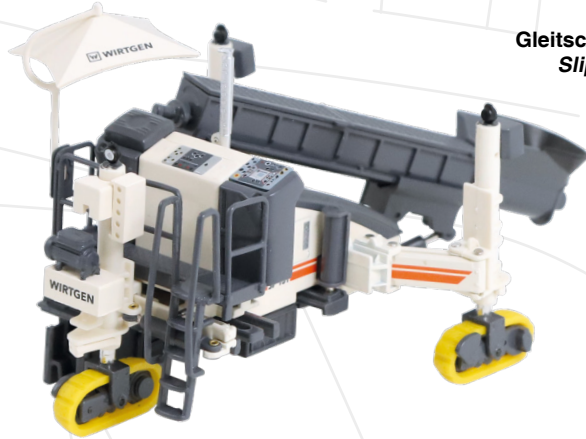

Wirtgen SP 15 i
Gleitschalungsfertiger mit Zuführschnecke /
Slipform paver with auger conveyor

(Newsletter 05/2022)

Maßstab / Scale : 1:50
 Länge / Length : 145 mm

Art.-No. 1054

Wirtgen W 120 Fi
Kaltfräse /
Cold milling machine

(Newsletter 18/2022)

Maßstab / Scale : 1:50
 Länge / Length : 270 mm

Art.-No. 1037



Wirtgen SP 64 i
Gleitschalungsfertiger /
Slipform paver

(Newsletter 18/2022)

Maßstab / Scale : 1:50
 Länge / Length : 210 mm

Art.-No. 1038

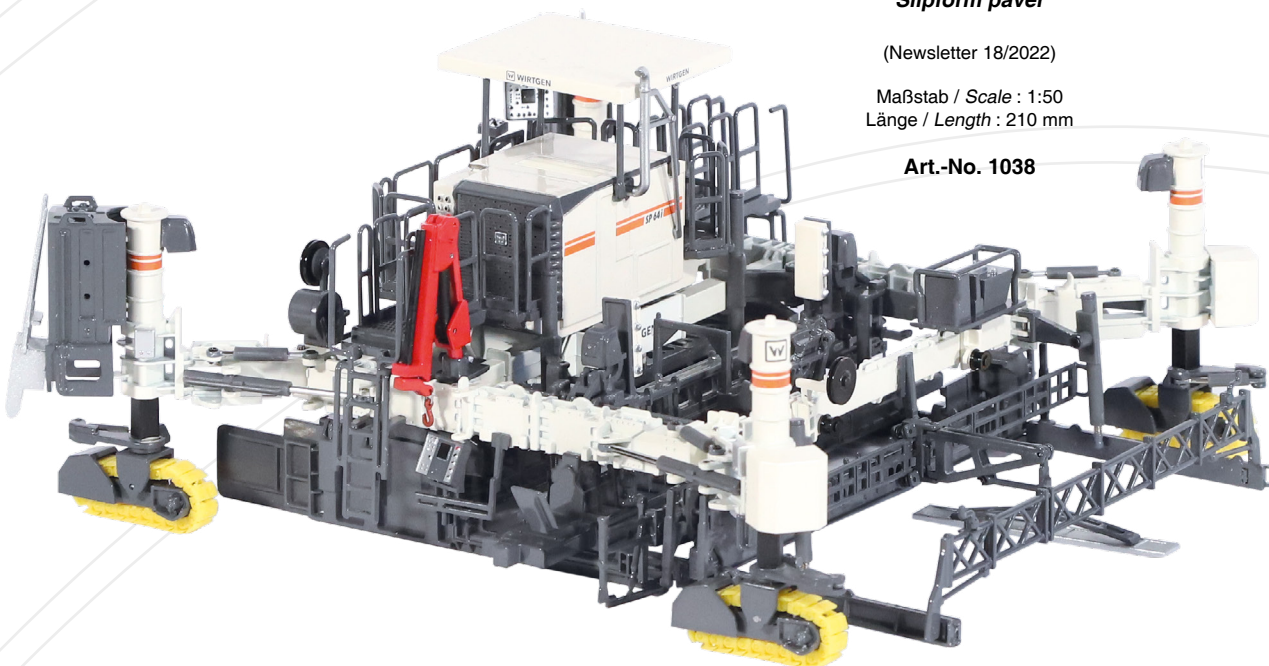



Schwing S 51 SX
Mercedes-Benz Arocs 10x4
Autobetonpumpe /
Truck mounted concrete pump

(Newsletter 18/2022)

Maßstab / Scale : 1:50
Länge / Length : 230 mm

Art.-No.: 1062



Schwing SLM 4600
Selbstladender Fahrmischer /
Self loading mixer

Maßstab / Scale : 1:50
Länge / Length : 110 mm

Art.-No.: 1056



„Weiß / White“

Art.-No. 1066/40

Mercedes-Benz Arocs 8x4
MirrorCam
Meiller-Kipper

(Newsletter 12/2022)

Maßstab / Scale : 1:50
Länge / Length : 175 mm



„Silbergrau / Silver grey“

Art.-No. 1066/55



„Blau / Blue“

Art.-No. 1066/20





NZG
Nürnberger
Zinkdruckguss-Modelle GmbH
Sigmundstraße 147
90431 Nürnberg
Germany

phone: +49 911 659650
fax: +49 911 611776

email: info@nzg.de

 **NZG Modelle**

www.nzg.de

Alle Rechte liegen bei NZG. Jedwede Weiterverarbeitung, insbesondere Herstellung und Verkauf von Kopien, Nachgüssen sowie Umbauten oder Verbreitung von in Farbe bzw. Beschriftung oder sonstigen Merkmalen veränderten NZG-Modellen ist untersagt und wird im Falle der Zuwiderhandlung zivilrechtlich und strafrechtlich verfolgt.
Modell- und Farbänderungen sind vorbehalten.
NZG[®] und seine Markenzeichen sind auf NZG Nürnberger Zinkdruckguss-Modelle GmbH eingetragene Schutzrechte.
Marken-, Geschmacksmuster und Urheberrechte werden mit der Erlaubnis des jeweiligen Inhabers benutzt.

*All rights are reserved to NZG. Any kind of processing - especially the production and sale of copies, imitated castings as well as conversions or the distribution of NZG models in which painting, inscriptions or other features have been changed - is prohibited and will be prosecuted in the case of contravention.
The line of products is subjected to change without notice.
NZG[®] and their design marks are registered trademarks of NZG Nürnberger Zinkdruckguss-Modelle GmbH
Brands, design rights and copyrights to be used by authority of the respective holder.*

 and Mercedes-Benz are the intellectual property of Mercedes-Benz Group AG.
They are used by NZG Modelle GmbH under license.
All truck-specific claims, trademarks, logos and designs may be intellectual property of Daimler Truck AG and are used by NZG Modelle GmbH under license.